

ON REQUEST - AUS ANFRAGE - SUR DOMANDE - SU RICHIESTA

Holder - Velohalter Support - Supporti

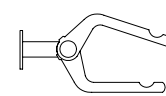

Mod. M20

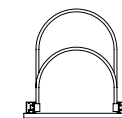

Mod. H-14 15

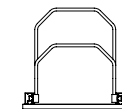

Mod. H-16 17

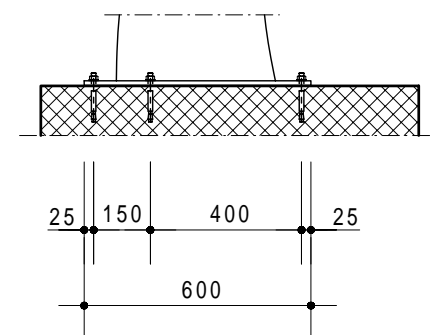

Trattamento: Ferro zincato a bagno	Alu ossidato naturale	N° pezzi
Committente:		N° ordine
Modello: LUGANO D	Materiale: FE - ALU - PLEXI	Data: Sett. 05
Descrizione COPERTURA CICLI E MOTOCICLI " LUGANO D "		Disegnato: GB
ÜBERDACHUNGEN FAHRRADRÄDER UND MOTORRÄDER " LUGANO D "		Scala: ---
 <p>Weberrütistrasse 9 8833 Samstagern T 044 783 22 44 F 044 783 22 43 info@kern-studer.ch www.kern-studer.ch</p>		N° dis. / Articolo LUGANO D500