

Plane of foundation
Fundamentplan
Plan de fondation
Schema fondazioni

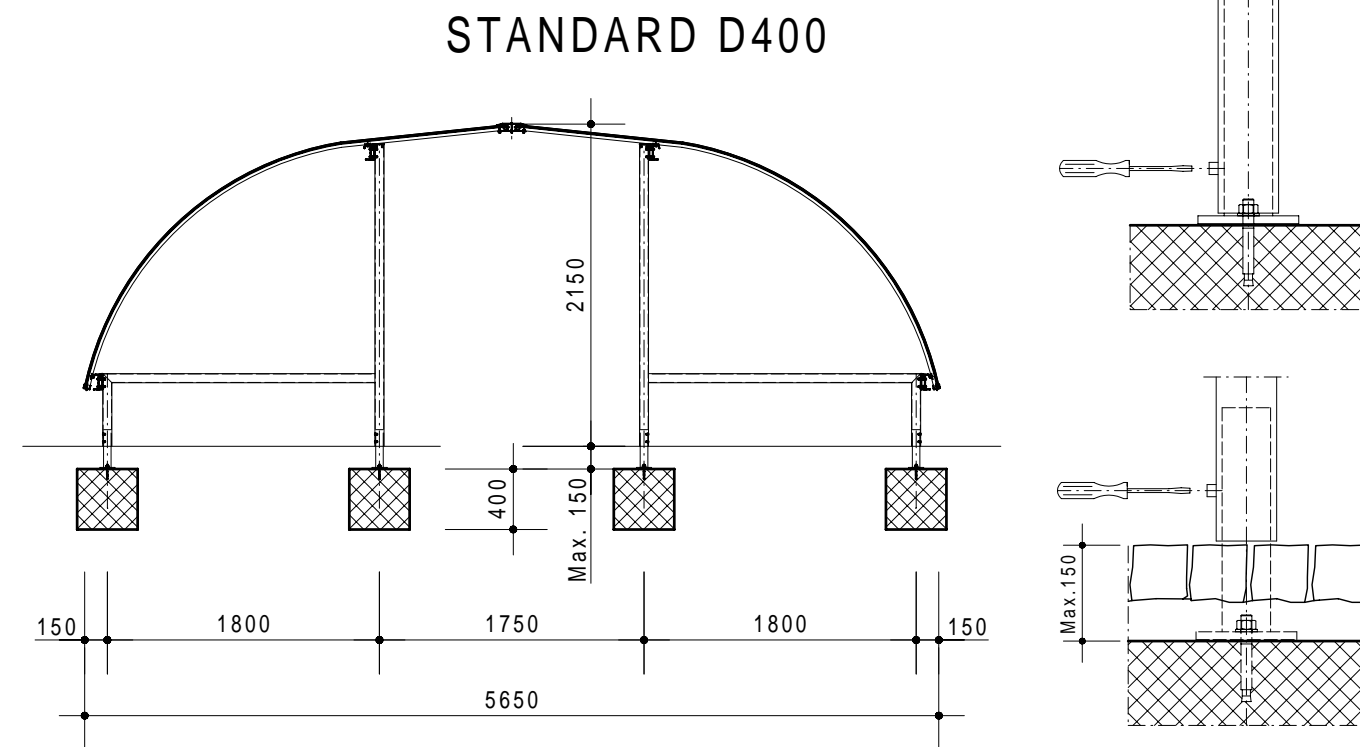

ON REQUEST - AUS ANFRAGE - SUR DEMANDE - SU RICHIESTA

Wall side - Seitenwände
Finition laterales - Pareti laterali

Holder - Velohalter
Support - Supporti

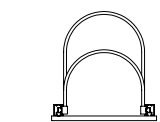
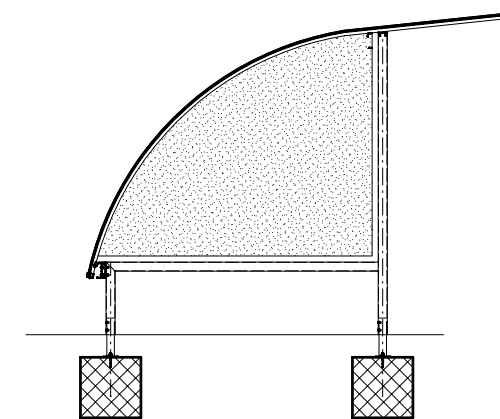

Mod. H-14 15

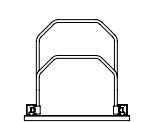

Mod. H-16 17

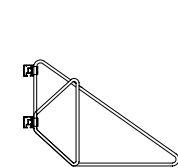

Mod. D-12 13

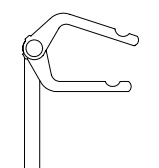

Mod. M20

Trattamento: Ferro zincato a bagno	Alu ossidato naturale	N° pezzi
Committente:		N° ordine
Modello: STANDARD D	Materiale: FERRO - STAHL	Data: Sett. 05
Descrizione COPERTURA CICLI E MOTOCICLI " STANDARD D "		Disegnato: GB
ÜBERDACHUNGEN FAHRRADRÄDER UND MOTORRÄDER " Standard D "		Scala: ---
 <p>Weberrütistrasse 9 8833 Samstagern T 044 783 22 44 F 044 783 22 43 info@kern-studer.ch www.kern-studer.ch</p>		<p>N° dis. / Articolo</p> <h1>STANDARD D400</h1>